



Aluminum electrolytic capacitors

Large-size capacitors

Series/Type: B41605
Date: December 2006

Long-life grade capacitors

Applications

- High-reliability equipment in automotive power electronics, e.g. integrated starter alternator
- Applications with highest ripple current load at high frequencies

Features

- High reliability and long useful life, up to 2000 h at 140 °C
- Very high ripple current capability optimized for high frequencies
- Compact design
- Vibration resistance up to 40 g
- Shelf life up to 15 years at storage temperatures up to 40 °C.
To ensure solderability, the capacitors should be built into the application within one year of delivery. After a total of two years' storage, the operating voltage must be applied for one hour to ensure the specified leakage current.

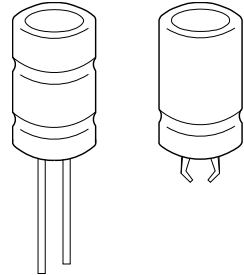

Construction

- Charge/discharge-proof, polar
- Aluminum case, fully insulated
- Up to 40 g vibration stability version with wired terminals and corrugation
- Snap-in solder version with pins to hold component in place on PC-board
- Minus pole not insulated from case
- Overload protection (safety vent)
- Without insulation sleeve upon request

Terminals

- Standard vibration version with wired terminals, weldable and solderable
- Snap-in with 3 terminals, protection against polarity reversal
- Up to 40 g vibration stability version with wired terminals, weldable and solderable

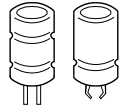
Specifications and characteristics in brief

Rated voltage V_R	25 ... 63 V DC	
Surge voltage V_S	$1.15 \cdot V_R$	
Rated capacitance C_R	1500 ... 20000 μF	
Capacitance tolerance	$\pm 20\% \triangleq M$	
Leakage current I_{leak} (5 min, 20 °C)	$I_{\text{leak}} \leq 0.006 \mu\text{A} \cdot \left(\frac{C_R}{\mu\text{F}} \cdot \frac{V_R}{V} \right) + 4 \mu\text{A}$	
Self-inductance ESL	10 nH	
Useful life 140 °C, V_R , $0.6 \cdot I_{\text{AC,R}}$ 125 °C, V_R , $I_{\text{AC,R}}$ 85 °C, V_R , $2.3 \cdot I_{\text{AC,R}}$ 40 °C, V_R , $2.0 \cdot I_{\text{AC,R}}$	> 2000 h > 5000 h > 20000 h > 500000 h	Requirements: $\Delta C/C$ $\leq \pm 30\%$ of initial value ESR ≤ 3 times initial specified limit $I_{\text{leak}} \leq$ initial specified limit
Voltage endurance test 125 °C, V_R	2000 h	Post test requirements: $\Delta C/C$ $\leq \pm 10\%$ of initial value ESR ≤ 1.3 times initial specified limit $I_{\text{leak}} \leq$ initial specified limit
Vibration resistance test	To IEC 60068-2-6, test Fc: 40 g vibration stability version	
	Displacement amplitude 3 mm, frequency range 10 Hz ... 2 kHz, acceleration max. 40 g, duration 3×2 h. Capacitor mounted by its body which is rigidly clamped to the work surface.	Snap-in version with 3 terminals and version with wired terminals Displacement amplitude 0.75 mm, frequency range 10 Hz ... 2 kHz, acceleration max. 10 g, duration 3×2 h. Capacitor mounted by its body which is rigidly clamped to the work surface.
IEC climatic category	To IEC 60068-1: 55/125/56 (–55 °C/+ 125 °C/56 days damp heat test)	
Detail specification	Similar to CECC 30301-809	
Sectional specification	IEC 60384-4	

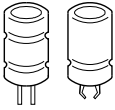

B41605

Automotive – up to 140 °C

Dimensional drawings

Large-size capacitor, up to 40 g vibration stability version with wired terminals

- *) Permissible range of positions for minus pole marking

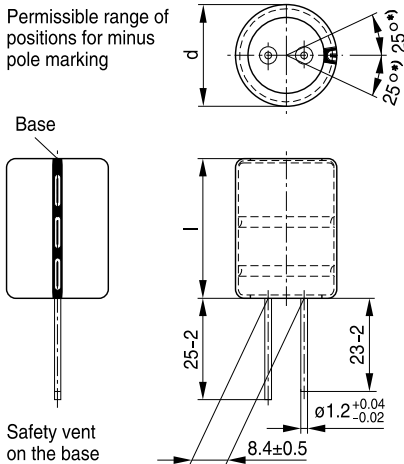

KAL0962-U-E

Dimensions and weights

Dimension (mm)		Approx. weight (g)
d +1	l ±2	
22	40	21
25	40	28
25	50	35
30	50	50
35	50	68

Packing units upon request.

Large-size capacitor, standard vibration version with wired terminals

- *) Permissible range of positions for minus pole marking

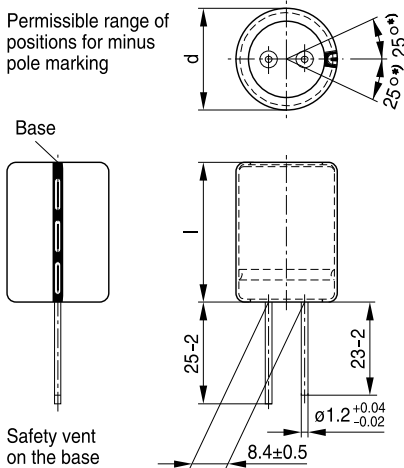

KAL1078-1

Dimensions and weights

Dimension (mm)		Approx. weight (g)
d +1	l ±2	
22	40	21
25	40	28
25	50	35
30	50	50
35	50	68

Packing units upon request.

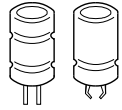

Large size capacitor, snap-in version with 3 terminals

Dimensions, weights and packing units

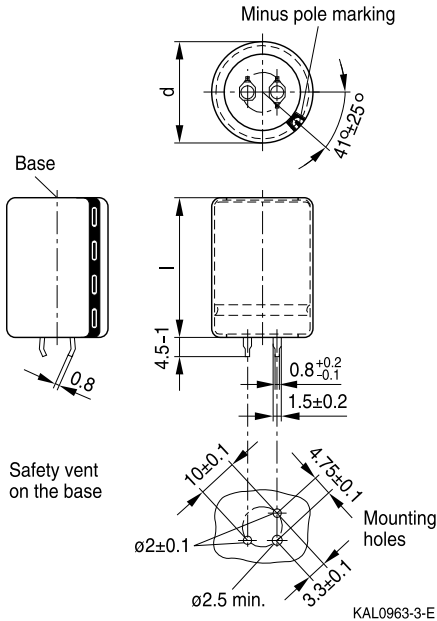

Dimensions (mm)		Approx. weight (g)	Packing units (pcs.)
$d + 1$	$l \pm 2$		
22	40	21	160
25	40	28	130
25	50	35	130
30	50	50	80
35	50	68	60

Packing of snap-in capacitors



For ecological reasons the packing is pure cardboard. Components can be withdrawn (in full or in part) in the correct position for insertion.

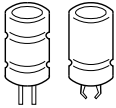

B41605
Automotive – up to 140 °C
Overview of available types

V_R (V DC)	25	40	55	63
	Case dimensions $d \times l$ (mm)			
C_R (μF)				
1500				22 × 40
1800			22 × 40	
2100				25 × 40
2700			25 × 40	25 × 50
3000		22 × 40		
3600			25 × 50	
3800		25 × 40		
4000				30 × 50
5000	22 × 40		30 × 50	
5400		25 × 50		
5600				35 × 50
6800	25 × 40			
7000			35 × 50	
10000	25 × 50			
13000	30 × 50			
20000	35 × 50			

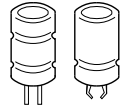
The capacitance and voltage ratings listed above are available in different cases upon request. Other voltage and capacitance ratings are also available upon request.

Case dimensions and ordering codes

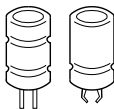
V_R	C_R 100 Hz 20 °C	Case dimensions d × l mm	Ordering code Snap-in version with 3 terminals	Ordering code Version with wired terminals	Ordering code Up to 40 g vibration stability version with wired terminals
V DC	μF				
25	5000	22 × 40	B41605A5508M002	B41605A5508M008	B41605A5508M009
	6800	25 × 40	B41605A5688M002	B41605A5688M008	B41605A5688M009
	10000	25 × 50	B41605A5109M002	B41605A5109M008	B41605A5109M009
	13000	30 × 50	B41605A5139M002	B41605A5139M008	B41605A5139M009
	20000	35 × 50	B41605A5209M002	B41605A5209M008	B41605A5209M009
40	3000	22 × 40	B41605A7308M002	B41605A7308M008	B41605A7308M009
	3800	25 × 40	B41605A7388M002	B41605A7388M008	B41605A7388M009
	5400	25 × 50	B41605A7548M002	B41605A7548M008	B41605A7548M009
55	1800	22 × 40	B41605A0188M002	B41605A0188M008	B41605A0188M009
	2700	25 × 40	B41605A0278M002	B41605A0278M008	B41605A0278M009
	3600	25 × 50	B41605A0368M002	B41605A0368M008	B41605A0368M009
	5000	30 × 50	B41605A0508M002	B41605A0508M008	B41605A0508M009
	7000	35 × 50	B41605A0708M002	B41605A0708M008	B41605A0708M009
63	1500	22 × 40	B41605A8158M002	B41605A8158M008	B41605A8158M009
	2100	25 × 40	B41605A8218M002	B41605A8218M008	B41605A8218M009
	2700	25 × 50	B41605A8278M002	B41605A8278M008	B41605A8278M009
	4000	30 × 50	B41605A8408M002	B41605A8408M008	B41605A8408M009
	5600	35 × 50	B41605A8568M002	B41605A8568M008	B41605A8568M009

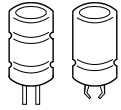

B41605
Automotive – up to 140 °C
Technical data

C_R	ESR _{typ}	ESR _{max}	ESR _{max}	ESR _{max}	Z _{max}	I _{AC,max}	I _{AC,R}	I _{AC,max}
100 Hz	100 Hz	100 Hz	100 Hz	10 kHz	100 kHz	10 kHz	10 kHz	10 kHz
20 °C	20 °C	20 °C	-40 °C	20 °C	20 °C	105 °C	125 °C	140 °C
μF	mΩ	mΩ	mΩ	mΩ	mΩ	A	A	A
V_R = 25 V DC								
5000	19	27	115	23	22	10.0	5.1	3.1
6800	14	19	80	15	15	13.5	6.9	4.1
10000	10	14	55	12	12	17.2	8.8	5.3
13000	9	12	45	11	11	18.8	9.6	5.8
20000	8	11	32	11	11	19.0	9.7	5.8
V_R = 40 V DC								
3000	22	31	115	24	23	9.8	5.0	3.0
3800	16	22	80	15	15	13.5	6.9	4.1
5400	12	16	60	11	11	17.2	8.8	5.3
V_R = 55 V DC								
1800	26	37	115	24	23	9.8	5.0	3.0
2700	17	24	80	15	15	13.5	6.9	4.1
3600	13	18	60	12	12	17.2	8.8	5.3
5000	11	15	45	11	11	18.7	9.6	5.8
7000	9	13	35	11	11	19.1	9.8	5.9
V_R = 63 V DC								
1500	28	39	115	23	22	9.6	4.9	2.9
2100	19	26	85	15	15	13.5	6.9	4.1
2700	15	21	65	12	12	17.2	8.8	5.3
4000	11	16	45	11	11	18.7	9.6	5.8
5600	9	13	35	11	11	19.1	9.8	5.9

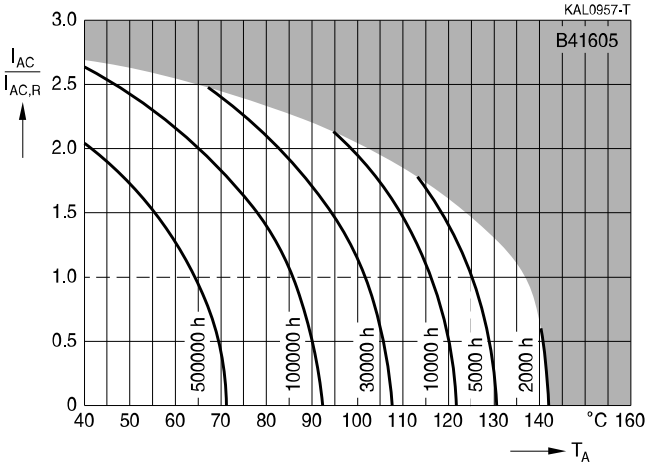

Useful life

depending on ambient temperature T_A under ripple current operating conditions at $V_R^{1)}$



Useful life

depending on case temperature T_C under ripple current operating conditions at $V_R^{1)}$

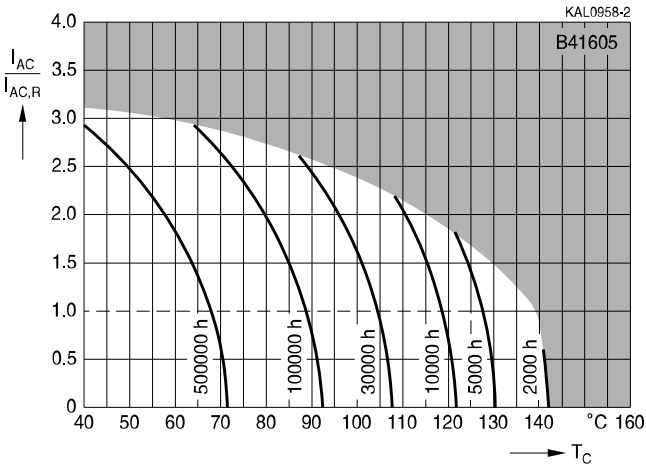

1) Refer to chapter "General technical information, 5.3 Calculation of useful life" for an explanation on how to interpret the useful life graphs

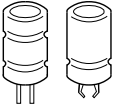

B41605

Automotive – up to 140 °C

Useful life

depending on ambient temperature T_A under ripple current operating conditions at $V_{op}^{2)}$

$V_R = 25 \text{ V}; V_{op} \leq 20 \text{ V}$

$V_R = 55 \text{ V}; V_{op} \leq 48 \text{ V}$

$V_R = 40 \text{ V}; V_{op} \leq 35 \text{ V}$

$V_R = 63 \text{ V}; V_{op} \leq 55 \text{ V}$

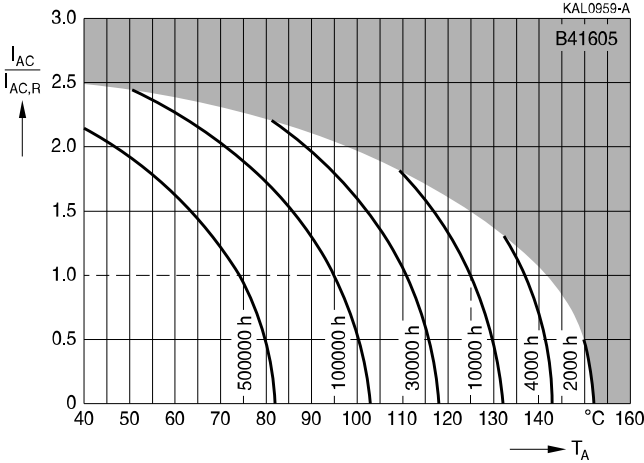

Useful life

depending on case temperature T_C under ripple current operating conditions at $V_{op}^{2)}$

$V_R = 25 \text{ V}; V_{op} \leq 20 \text{ V}$

$V_R = 55 \text{ V}; V_{op} \leq 48 \text{ V}$

$V_R = 40 \text{ V}; V_{op} \leq 35 \text{ V}$

$V_R = 63 \text{ V}; V_{op} \leq 55 \text{ V}$

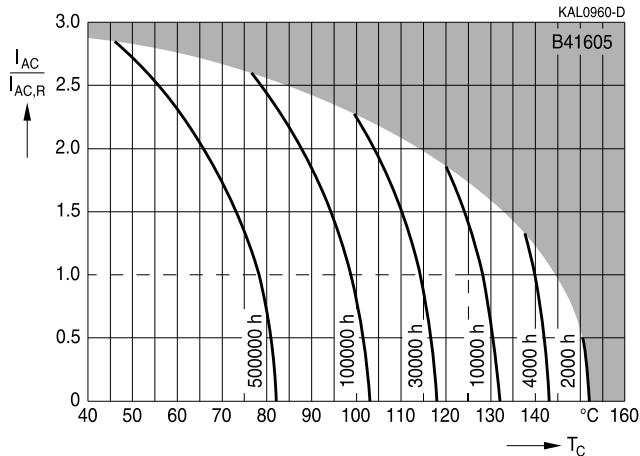

2) Refer to chapter "General technical information, 5.3 Calculation of useful life" for an explanation on how to interpret the useful life graphs

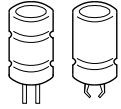

Frequency factor of permissible ripple current I_{AC} versus frequency f

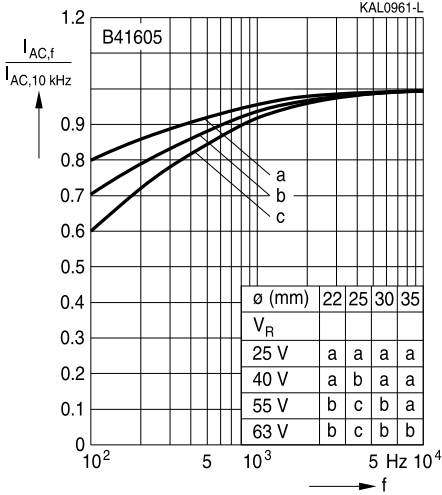

Frequency characteristics of ESR Typical behavior

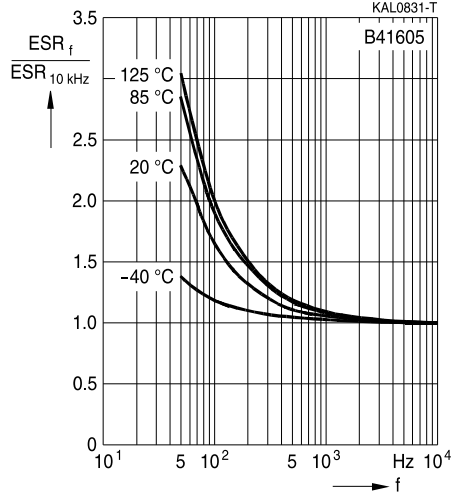

Equivalent series resistance ESR versus frequency f

Typical behavior for 2700 μ F/55 V

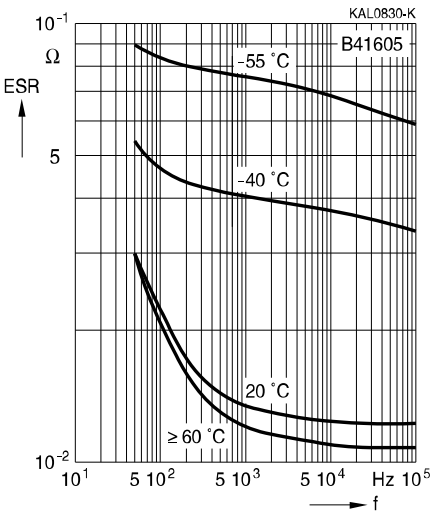

Impedance Z versus frequency f

Typical behavior for 2700 μ F/55 V

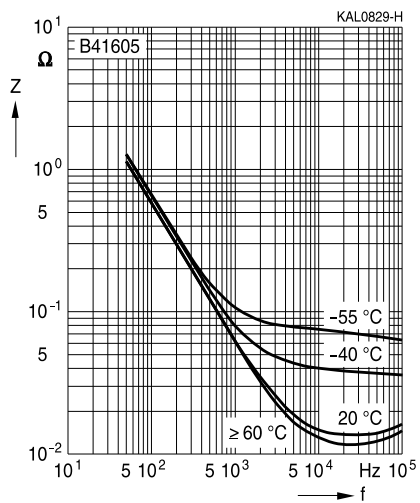

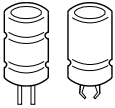

Cautions and warnings

Personal safety

The electrolytes used by EPCOS have not only been optimized with a view to the intended application, but also with regard to health and environmental compatibility. They do not contain any solvents that are detrimental to health, e.g. dimethyl formamide (DMF) or dimethyl acetamide (DMAC).

Furthermore, part of the high-voltage electrolytes used by EPCOS are self-extinguishing. They contain flame-retarding substances which will quickly extinguish any flame that may have been ignited.

As far as possible, EPCOS does not use any dangerous chemicals or compounds to produce operating electrolytes. However, in exceptional cases, such materials must be used in order to achieve specific physical and electrical properties because no safe substitute materials are currently known. However, the amount of dangerous materials used in our products has been limited to an absolute minimum. Nevertheless, the following rules should be observed when handling Al electrolytic capacitors:

- Any escaping electrolyte should not come into contact with eyes or skin.
- If electrolyte does come into contact with the skin, wash the affected parts immediately with running water. If the eyes are affected, rinse them for 10 minutes with plenty of water. If symptoms persist, seek medical treatment.
- Avoid breathing in electrolyte vapor or mists. Workplaces and other affected areas should be well ventilated. Clothing that has been contaminated by electrolyte must be changed and rinsed in water.

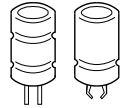

Product safety

The table below summarize the safety instructions that must be observed without fail. A detailed description can be found in the relevant sections of chapter "General technical information".

Topic	Safety information	Reference Chapter "General technical information"
Polarity	Make sure that polar capacitors are connected with the right polarity.	1 "Basic construction of aluminum electrolytic capacitors"
Reverse voltage	Voltages polarity classes should be prevented by connecting a diode.	3.1.6 "Reverse voltage"
Upper category temperature	Do not exceed the upper category temperatur.	7.2 "Maximum permissible operating temperature"
Maintenance	Make periodic inspections of the capacitors. Before the inspection, make sure that the power supply is turned off and carefully discharge the electricity of the capacitors. Do not apply any mechanical stress to the capacitor terminals.	10 "Maintenance"
Mounting position of screw terminal capacitors	Do not mount the capacitor with the terminals (safety vent) upside down.	11.1. "Mounting positions of capacitors with screw terminals"
Mounting of single-ended capacitors	The internal structure of single-ended capacitors might be damaged if excessive force is applied to the lead wires. Avoid any compressive, tensile or flexural stress. Do not move the capacitor after soldering to PC board. Do not pick up the PC board by the soldered capacitor. Do not insert the capacitor on the PC board with a hole space different to the lead space specified.	11.4 "Mounting considerations for single-ended capacitors"
Robustness of terminals	The following maximum tightening torques must not be exceeded when connecting screw terminals: M5: 2 Nm M6: 2.5 Nm	11.3 "Mounting torques"
Soldering	Do not exceed the specified time or temperature limits during soldering.	11.5 "Soldering"

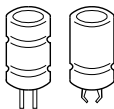

B41605

Automotive – up to 140 °C

Topic	Safety information	Reference Chapter "General technical information"
Soldering, cleaning agents	Do not allow halogenated hydrocarbons to come into contact with aluminum electrolytic capacitors.	11.6 "Cleaning agents"
Passive flammability	Avoid external energy, such as fire or electricity.	8.1 "Passive flammability"
Active flammability	Avoid overload of the capacitors.	8.2 "Active flammability"
		Reference Chapter "Capacitors with screw terminals"
Breakdown strength of insulating sleeves	Do not damage the insulating sleeve, especially when ring clips are used for mounting.	"Screw terminals - accessories"

Important notes

The following applies to all products named in this publication:

1. Some parts of this publication contain **statements about the suitability of our products for certain areas of application**. These statements are based on our knowledge of typical requirements that are often placed on our products in the areas of application concerned. We nevertheless expressly point out **that such statements cannot be regarded as binding statements about the suitability of our products for a particular customer application**. As a rule, EPCOS is either unfamiliar with individual customer applications or less familiar with them than the customers themselves. For these reasons, it is always ultimately incumbent on the customer to check and decide whether an EPCOS product with the properties described in the product specification is suitable for use in a particular customer application.
2. We also point out that **in individual cases, a malfunction of passive electronic components or failure before the end of their usual service life cannot be completely ruled out in the current state of the art, even if they are operated as specified**. In customer applications requiring a very high level of operational safety and especially in customer applications in which the malfunction or failure of a passive electronic component could endanger human life or health (e.g. in accident prevention or life-saving systems), it must therefore be ensured by means of suitable design of the customer application or other action taken by the customer (e.g. installation of protective circuitry or redundancy) that no injury or damage is sustained by third parties in the event of malfunction or failure of a passive electronic component.
3. **The warnings, cautions and product-specific notes must be observed.**
4. In order to satisfy certain technical requirements, **some of the products described in this publication may contain substances subject to restrictions in certain jurisdictions (e.g. because they are classed as “hazardous”)**. Useful information on this will be found in our Material Data Sheets on the Internet (www.epcos.com/material). Should you have any more detailed questions, please contact our sales offices.
5. We constantly strive to improve our products. Consequently, **the products described in this publication may change from time to time**. The same is true of the corresponding product specifications. Please check therefore to what extent product descriptions and specifications contained in this publication are still applicable before or when you place an order. We also **reserve the right to discontinue production and delivery of products**. Consequently, we cannot guarantee that all products named in this publication will always be available.
6. Unless otherwise agreed in individual contracts, **all orders are subject to the current version of the “General Terms of Delivery for Products and Services in the Electrical Industry” published by the German Electrical and Electronics Industry Association (ZVEI)**.
7. The trade names EPCOS, EPCOS-JONES, BAOKE, Alu-X, CeraDiode, CSSP, MLSC, PhaseCap, PhaseMod, SIFERRIT, SIFI, SIKOREL, SilverCap, SIMID, SIOV, SIP5D, SIP5K, UltraCap, WindCap are **trademarks registered or pending** in Europe and in other countries. Further information will be found on the Internet at www.epcos.com/trademarks.